

RESEARCH OUTPUTS / RÉSULTATS DE RECHERCHE

Hydrothermal Carbonization (HTC) pellets quality assessment

Lovella, Yaniel Garcia; Goel, Abhishek; Garin, Louis; Blondeau, Julien; Bram, Svend

Published in:

36th International Conference on Efficiency, Cost, Optimization, Simulation and Environmental Impact of Energy Systems, ECOS 2023

DOI:

[10.52202/069564-0087](https://doi.org/10.52202/069564-0087)

Publication date:

2023

Document Version

Publisher's PDF, also known as Version of record

[Link to publication](#)

Citation for published version (HARVARD):

Lovella, YG, Goel, A, Garin, L, Blondeau, J & Bram, S 2023, Hydrothermal Carbonization (HTC) pellets quality assessment: combustion kinetics, efficiency and emissions. in *36th International Conference on Efficiency, Cost, Optimization, Simulation and Environmental Impact of Energy Systems, ECOS 2023*, 10.52202/069564-0087, 36th International Conference on Efficiency, Cost, Optimization, Simulation and Environmental Impact of Energy Systems, ECOS 2023, International Conference on Efficiency, Cost, Optimization, Simulation and Environmental Impact of Energy Systems, pp. 965-976, 36th International Conference on Efficiency, Cost, Optimization, Simulation and Environmental Impact of Energy Systems, ECOS 2023, Las Palmas de Gran Canaria, Spain, 25/06/23. <https://doi.org/10.52202/069564-0087>

General rights

Copyright and moral rights for the publications made accessible in the public portal are retained by the authors and/or other copyright owners and it is a condition of accessing publications that users recognise and abide by the legal requirements associated with these rights.

- Users may download and print one copy of any publication from the public portal for the purpose of private study or research.
- You may not further distribute the material or use it for any profit-making activity or commercial gain
- You may freely distribute the URL identifying the publication in the public portal ?

Take down policy

If you believe that this document breaches copyright please contact us providing details, and we will remove access to the work immediately and investigate your claim.

Hydrothermal Carbonization (HTC) pellets quality assessment: combustion kinetics, efficiency and emissions

Yaniel Garcia Lovella^{a,b,g}, Abhishek Goel^{c,g}, Louis Garin^d, Julien Blondeau^{e,g} and Svend Bram^{e,g}

^a Vrije Universiteit Brussel (VUB), Faculty of Engineering, Thermo and Fluid dynamics (FLOW), Brussels, Belgium, yaniel.garcia.lovella@vub.be, CA

^b Universidad Central "Marta Abreu" de Las Villas (UCLV), Faculty of Industrial and Mechanical Engineering, Santa Clara, Cuba, yanielg@uclv.cu

^c Vrije Universiteit Brussel (VUB), Faculty of Engineering, Thermo and Fluid dynamics (FLOW), Brussels, Belgium, abhishek.goel@vub.be

^d Université de Namur (UNamur), Nanomaterials Chemistry Research Unit, Namur, Belgium, louis.garin@unamur.be

^e Vrije Universiteit Brussel (VUB), Faculty of Engineering, Thermo and Fluid dynamics (FLOW), Brussels, Belgium, julien.blondeau@vub.be

^f Vrije Universiteit Brussel (VUB), Faculty of Engineering, Thermo and Fluid dynamics (FLOW), Brussels, Belgium, svend.bram@vub.be

^g Brussels Institute for Thermal-Fluid Systems and clean Energy (BRITE), Vrije Universiteit Brussel (VUB) and Université Libre de Bruxelles (ULB), Belgium, svend.bram@vub.be

Abstract:

In current times, climate change due to greenhouse gas (GHG) emissions and rising fossil fuel prices create the need to focus more on renewable energy to become energy independent. The combustion of solid fuels such as biomass is a reliable option for thermal energy production and for combined heat and power production. This work focuses on the quality analysis of carbon-rich solid fuel produced by Hydrothermal Carbonization (HTC) of green waste (such as leaves, small branches, and grass). The combustion and emission performances of the HTC pellets are compared to those of conventional softwood pellets. Thermogravimetric analysis, kinetics assessment, and final use tests on a fixed bed boiler were carried out for both fuels. Combustion efficiency, boiler efficiency, and emissions factors were experimentally determined, computed and compared. Thermogravimetric analyses of the fuels show some qualitative and quantitative differences, in particular a third peak of burning rate corresponding to the oxidation of solid carbon, with a high activation energy. For similar parameters of boiler operation with HTC pellets, a 7% increase in combustion efficiency and a 7% increase in boiler efficiency were observed. However, higher particulate matter and CO emissions were observed. Results suggest that the air/fuel ratio can be further optimized for the use of HTC pellets for this type of boiler. This makes HTC pellets a promising fuel to help tackle climate change.

Keywords:

HTC pellets; softwood pellets; thermogravimetric analysis; boiler efficiency; PM; gaseous emissions.

1. Introduction

In the last few decades, biomass as an energy resource has been considered an attractive alternative to fossil fuels in reaching the European target to reduce carbon dioxide emissions [1]. Nevertheless, others transformation routes of biomass into more valorized goods can be considered, such as biochemical products and raw materials for other industries. This could transform the perspective of biomass as an energy resource, especially woody biomass [2]. Biomass resources from agriculture wastes, grass, leaves, sludge from anaerobic digestion, and urban green wastes have great potential as energy resources. However, such resources with low energy density, high moisture, and high alkali content are still challenging to direct combustion in conventional boilers, especially in issues related to ash formation [3]. Therefore, biomass resource pre-treatments and raw biomasses upgrade into better-quality biofuels have a substantial potential to increase the feasibility of their use for heat and power generation [4, 5].

Hydrothermal carbonization (HTC) has been considered an efficient alternative for upgrading raw combustible material [6], especially for organic feedstock with high moisture contents [7]. Nevertheless, the final use of

such solid fuel, as well as biomass fuels, brings some attention to the emissions issues, especially particulate matter emissions [8, 9]. Therefore, the present study aims to carry out a thermal and emission characterization of HTC pellets through a kinetics description of the fuel, as well as a final use combustion experiment in a 40 kW pellets boiler for efficiency and emission assessment.

2. Material and methods

HTC pellets produced via HTC treatment of green waste were tested and compared to softwood pellets as a reference. The kinetics description was developed by employing Thermogravimetric Analysis (TGA) in a Mettler Toledo TGA/DSC 3+ STARe System. The TGA experiments were conducted under an air atmosphere of 60.0 mL/min, for both softwood pellets and HTC pellets.

The thermal and environmental efficiency of HTC pellets combustion was assessed at the Vrije Universiteit Brussel biomass laboratory on a 40 kW laboratory boiler manufactured by HS TARM (USA). It has a gas-in-tube heat exchanger with helical rods. The boiler is designed for fuels in the form of pellets and chips. It is connected to the thermal network equipped with a PLC control system from Siemens (Desigo CC Compact). It is equipped with various sensors to control and measure the flow rate and temperatures along the network and on the exhaust gas. Two combustion tests were carried out, the first using a high-quality fuel as wood pellets, which was taken as a reference for the second test using HTC pellets. In both tests, the exhaust gas composition was measured with a portable emission analyzer HORIBA PG-250. The particulate matter was measured using an ELPI+ (Electrostatic Low-Pressure Impactor). Additionally, the flue gas temperature and circulation water temperatures were measured. Also, the fuel hopper was continuously weighted to account for the fuel consumption rate.

2.1. Experimental setup for emissions assessment

Figure 1 shows a scheme of the measurement equipment used for conducting the softwood pellets and HTC pellets tests.

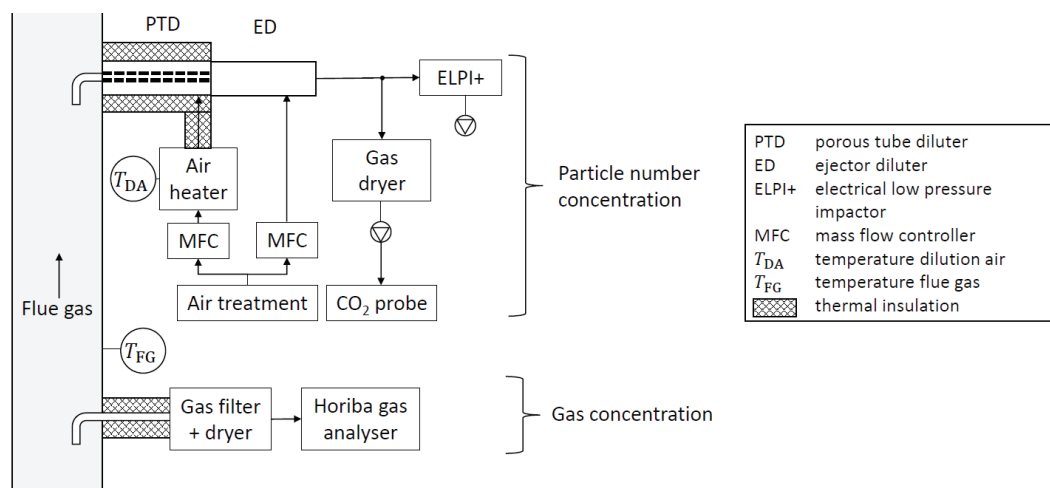

Figure 1. Scheme of equipment for measuring particulate and gaseous emissions. Source: taken from [10] and modified by the authors.

While performing the particulate matter (PM) measurement with the ELPI+, the flue gases were first diluted in a dilution system to control parameters like temperature, humidity, and particulate concentration according to the specifications of the measuring device. This configuration increases the instrument's life and minimizes the probability of modifications in the PM distribution due to aerosol chemistry during the measurement process. In this particular setup, a two-stage dilution system manufactured by Venacontra has been used, as shown in [11].

2.2. Indexes for combustion characterization and kinetics

The ignition and burnout characteristics of a fuel are commonly related to the ignition temperature (T_i) and the burnout temperatures (T_b). Ignition temperatures are estimated graphically (Tangent Method), and the first peak point of the TG first-derivate (DTA) is used as an intersection point with the TG curve, as it is described in [12, 13].

The fuel thermal degradation is expressed as Eq. (1) shows, with W_i being the initial mass fraction of the sample, W the remaining mass fraction of the sample, and W_f the final mass fraction of the sample

$$\alpha = \frac{W_i - W}{W_i - W_f} \quad (1)$$

The burnout temperature can be estimated via the ‘‘Conversion Method’’, suggested by [14]. The method uses a simple criterion for selecting the burnout temperature, which considers T_b at the point where the fuel reaches 99% of thermal degradation ($\alpha = 0.99$). Also, the tangent method can be used. Nevertheless, authors such as Liu et al. suggest that in cases where the air is used as a carrier gas during TGA two distinct peaks appeared; then the tangent method should be used for the estimation of burnout temperature by using the second DTG peak as intersection point instead of the first DTG peak [12].

Combustion characteristics of biomass fuels can be assessed by the index S [15], Eq. (2) shows the formula to compute a comprehensive combustion index

$$S = \frac{(dX/dt)_{\max} \cdot (dX/dt)_{\text{mean}}}{T_i^2 \cdot T_b} \quad (2)$$

The index considers the maximum fuel conversion rate $[(dX/dt)_{\max}]$ and the average value $[(dX/dt)_{\text{mean}}]$. According to [16], a higher comprehensive combustion index represents a higher fuel reactivity and thus a better combustion performance of the fuel. In a biomass combustion process, pyrolysis is one of the most difficult stages to accurately account for. Nevertheless, some general conversion routes can be assumed, of the form: biomass \rightarrow char + volatiles + gases. Depending on the pyrolysis regime, the amount of products can vary [17, 18]. In this work, the combustion reaction kinetics of softwood pellets and HTC pellets are studied by using data obtained from TGA experiments. There are several methods available in the literature for modelling the combustion reaction kinetics, such as the Kissinger-Akahira-Sunose (KAS) method [19, 20], Ozawa-Flynn-Wall method (OSF) [21, 22] or Coats – Redfern method [23]. The present study selected the Coats – Redfern method, considering the simplicity of the method and the possibility to estimate the activation energy as well as the pre-exponential factor.

2.3. Efficiency and emission factor calculation

Besides the theoretical study of the combustion reaction kinetics of the HTC pellets, the final use application of this HTC fuel was also assessed experimentally. In the present study, the boiler and combustion efficiencies are calculated from the parameters measured during the experiments, in this case using a more practical approach. Equation (3) shows the efficiency calculation of a boiler using the direct method

$$\eta_B = \frac{\dot{Q}_L}{\dot{Q}_F} \quad (3)$$

\dot{Q}_L represents the thermal power transferred from the fuel to the feeding water of the boiler. As the water vapour in the exhaust gases is not condensed, the LHV is used to compute the thermal power from the fuel \dot{Q}_F . The indirect method for computing the efficiency in the boiler is a more interesting option, considering the possibility to identify the critical point related to all the effects that cause a reduction in boiler efficiency. However, a boiler and combustion efficiency calculation by the indirect method require a representative sampling of bottom and fly ashes in the boiler. In a small fixed-bed boiler, at least 24 hours of operation will be necessary to get an expected amount of bottom ash, completing one cycle of ash out of bed. Nevertheless, Good and Nussbaumer have proposed and simplified method for computing the combustion efficiency of biomass boilers [24, 25]. The method has been successfully applied if $\text{CO} \leq 0.5 \text{ vol}\%$, $\text{CO}_2 \geq 5 \text{ vol}\%$ and for exhaust gas temperatures below 400°C [26].

$$\eta_C = 100 - L_{\text{Th}} - L_{\text{Ch}} \quad (4)$$

Equation (4) relates the combustion efficiency to two parameters: the thermal (L_{Th}) and chemical losses (L_{Ch}).

$$L_{\text{Th}} = \frac{(T_{\text{fg}} - T_A) \left\{ 1.39 + \frac{122}{\text{CO}_2 + \text{CO}} + 0.02 \cdot u \right\}}{\frac{\text{LHV}}{100} - 0.2442 \cdot u} \quad (5)$$

$$L_{\text{Ch}} = \frac{\text{CO}}{\text{CO}_2 + \text{CO}} \frac{11800}{\frac{\text{LHV}}{100} - 0.2442 \cdot u} \quad (6)$$

T_{fg} and T_A stand for the temperature of the exhaust gases and atmosphere. CO and CO_2 are the carbon monoxide and carbon dioxide volume fractions of the dry flue gases. u represents the fuel moisture expressed in percentage.

Additionally, expressing the energy balance on the boiler, some approximation of the losses regarding unburned carbon on bottom and fly ash can be made. Equation (7) represents the energy balance for a steady-state operation of the boiler

$$\dot{E}_{\text{in}} = \dot{E}_{\text{out}} \quad (7)$$

Then, identifying all energy flows involved in the process, as Eq. (8) shows, an estimation of energy losses regarding unburned fuel (\dot{Q}_{UBF}) can be computed as

$$\dot{Q}_F = \dot{Q}_L + \dot{Q}_{FG} + \dot{Q}_{UBF} + \dot{Q}_{RC}. \quad (8)$$

The values of the thermal load and thermal power from the fuel are known values from the direct method mentioned earlier. The losses by radiation and convection (\dot{Q}_{RC}) of the boiler can be neglected. However, Lyubov et al. found that for industrial hot-water boilers, the losses by convection and radiation to the environment are less than 0.5% of the thermal power supplied by the fuel to the boiler furnace [27]. Then, with the value of losses by unburned fuel, Eq. 9 can be used to compute the combustion efficiency, which is based on the total power from the fuel and the power not used by unburned fuel.

$$\eta_C = \left(1 - \frac{\dot{Q}_{UBF}}{\dot{Q}_F}\right), \quad (9)$$

The emission factors (EF) are computed on an energy density basis, allowing to compare emissions factors from different combustion tests without considering differences in oxygen concentrations.

$$EF_e = \frac{\dot{m}_i/\Delta t}{(\dot{m}_f/\Delta t) \cdot LHV}. \quad (10)$$

In Eq. (10), m_i represent the mass of each pollutant emitted during the considered time window (Δt). The emissions factors for particle number of $PM_{2.5}$ and PM_{10} are computed according to Eq. 9-10.

$$n_{PM} = y_n \cdot DR_2 \cdot \dot{V}_{fg,dil,dry}, \quad (11)$$

$$EF_{PMx} = \frac{n_{PM}/\Delta t}{(\dot{m}_f/\Delta t) \cdot LHV}. \quad (12)$$

In Eq. (11), y_n represents the particle number, DR_2 stands for dilution ratio at dilution stage two and $\dot{V}_{fg,dil,dry}$ represent the volumetric flow of diluted exhaust gases at dry conditions.

3. Results and discussions

3.1. Characterization of fuel combustion

Table 1 summarizes the significant properties of physicochemical characterization of the fuels burned during the TGA experiments and the combustion tests. It can be noticed that HTC pellets have a higher Lower Heating Value (LHV) than softwood pellets, about 18% higher. The higher LHV of the HTC pellet is reflected in the higher fixed carbon content, which is expected in a highly carbonized product obtained from the HTC process. From elemental composition, chlorine compound is present in the tested HTC pellets, in low amounts but still the potential source of corrosion issues.

Table 1. Physicochemical characterization of the analyzed fuels. Source: data adapted from [10, 28, 29].

Property	Units	Softwood pellets	HTC pellets
Bulk density	kg/m ³	≥630	696
Lower Heating Value	MJ/kg_db	≥18.8 ^a	23.12
Higher Heating Value	MJ/kg_db	≥20.2 ^a	24.36
Moisture content	wt%, ar	<8	5.8
Volatile matter	wt%, ar	(77.7)	69.1
Fixed carbon	wt%, ar	(22.3)	30.9
Ash content	wt%, ar	(0.3)	11.0
Carbon (C)	wt%, db	(52.2)	57.9
Hydrogen (H)	wt%, db	(5.9)	5.7
Nitrogen (N)	wt%, db	≤0.3	1.26
Oxygen (O)	wt%, db	(39.1)	23.3
Sulfur (S)	wt%, db	≤0.04	0.137

wt%: percentage on weight basis; ar: as received; db: dry basis; daf: dry basis and ash free. The values in brackets are the median of similar softwood pellets taken for the original author [10] from the public Phyllis2 database. ^aThe heating values were computed by the original author [10] using the Boie model [30].

In general, during TGA experiments of lignocellulose-biomass under oxidative conditions, an initial drying step can be observed (of free water, crystal water and absorbed water) which extends from room temperature up to about 170°C (A). The second step is when volatilization and combustion of volatiles start, which could extend from about 120°C up to about 420°C (B). Then, a third step of char oxidation starts from a range temperature

of about 310°C up to about 520°C (C). Finally, the burnout step appears, when all remaining char is depleted, starting at about 480°C (D) [31, 32]. The temperature range of each step of biomass combustion shown by the TGA experiments varies with the type of biomass and is also affected by the heating rate. However, the values showed could be taken as reference values for other biomass samples, considering that the mentioned author analysed 12 different biomass resources with heating rates of 10 °C/min and 20 °C/min.

Figure 2(b) shows the TGA of softwood pellets and Fig. 2(a) shows the derivative thermogravimetric curve (DTG) of softwood pellets. The drying step extends from 25°C up to 95°C. It is followed by an almost flat zone, where a nearly constant weight loss rate (of about 0.42%) is observed, over a temperature range of about 100°C. The more active drying range and the almost constant weight loss rate were grouped into step A. Step B corresponds to the release and combustion of volatiles, coming from the hemicellulose at the beginning of the step and cellulose at the end of the step. It is where the highest weight loss is observed, between 197°C and 357°C. Step C is in a range of about 357°C to 500°C, where the char coming from the lignin is oxidized, however, some authors point out that some char could appear at the end of step B as well [17, 33, 34]. The burnout step starts from 500°C, where char is completely oxidised. For the purpose of the present analysis, two zones were further studied, zone I (197°C - 357°C) and zone II (357°C - 500°C).

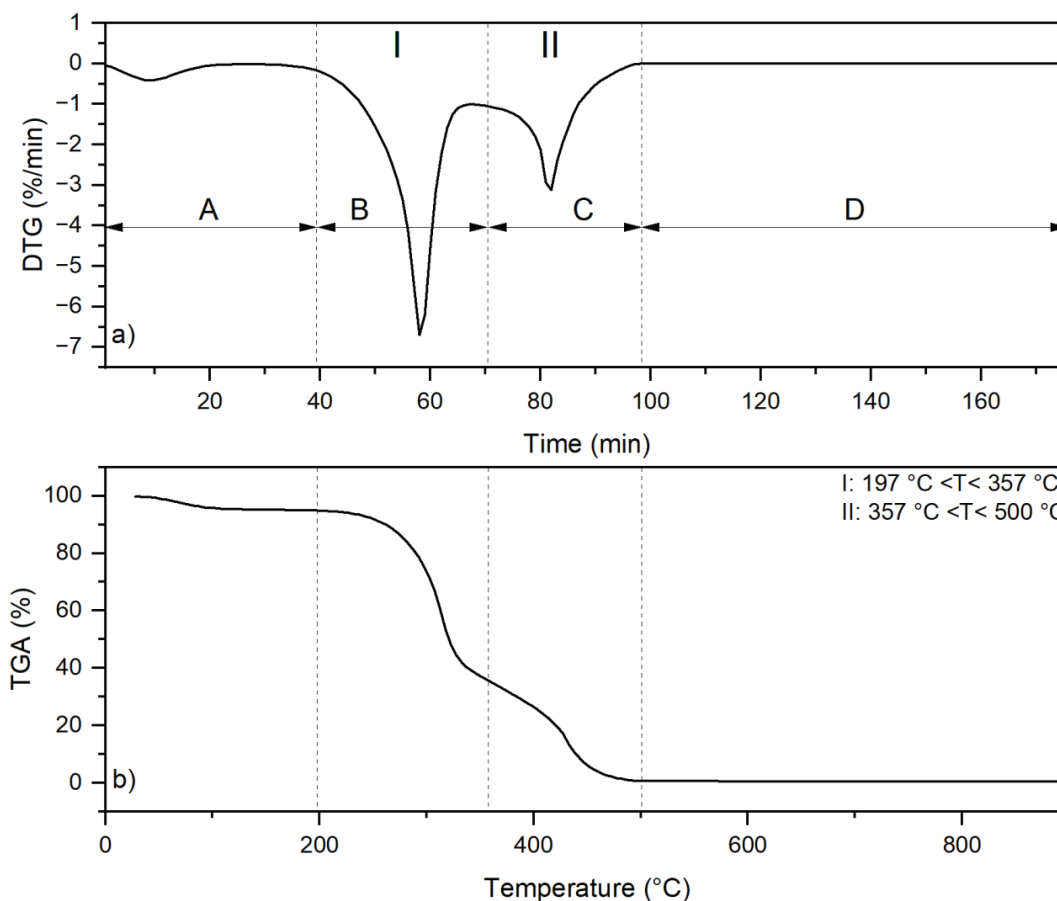

Figure 2. Thermal degradation of softwood pellets, a) the derivative of thermogravimetry (DTG) analysis and b) thermogravimetry analysis (TGA).

Figure 3(b) shows the TGA of HTC pellets and Figure 3(a) shows the derivative thermogravimetric curve (DTG) of HTC pellets. As for the softwood pellets, four steps can be identified (A to D), but there are some important differences in these combustion steps. Step A extends in the temperature range of about 15°C more for HTC pellets than for softwood pellets. Additionally, two distinct peaks can be appreciated. The first one is from 25°C to 117°C, which is assumed to correspond to the evaporation of free water in the fuel and the second from 117°C to 212°C, corresponding to the evaporation of the crystal water and absorbed water, contained in the ashes which in this case is about 36 times higher than for softwood pellets. Step B extends from 212°C to 322°C. The temperature span for this step is 50°C less for HTC pellets than for softwood pellets, which suggests a smaller quantity of volatiles released for the HTC pellets case, as confirmed by the volatile contents given in Table 1.

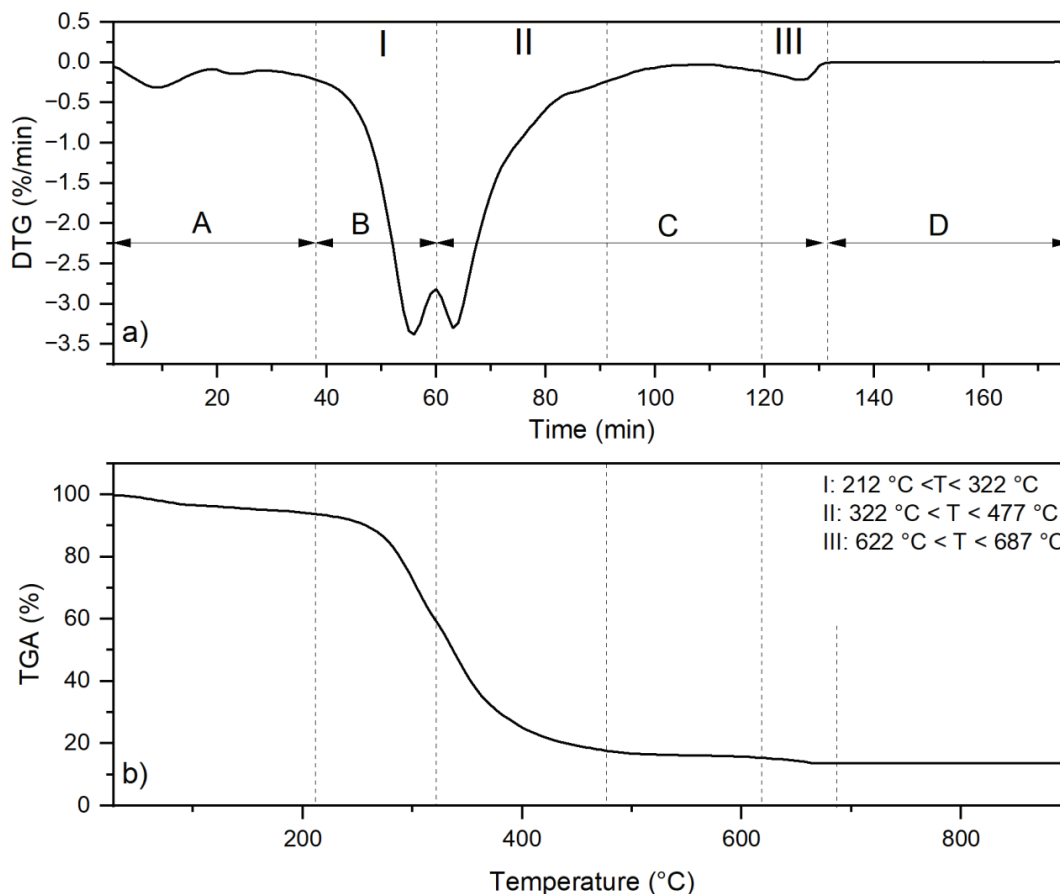

Figure 3. Thermal degradation of HTC pellets, a) the derivative of thermogravimetry (DTG) analysis and b) thermogravimetry analysis (TGA).

Step C, from Figure 3a, shows a quite different shape for HTC pellets than for softwood pellets. The peak corresponding to the zone of maximum burning rate for step C is similar to the peak observed in step B. Also, the burning rate is quantitatively similar, however, step C starts at 322°C and ends at about 477°C. For the softwood pellets the higher part of the fuel mass is released in step B: 59.3% versus 34.9% during step C. The opposite trend is observed for HTC pellets, 34.5% of the mass is released in step B, versus 45.4% in step C. Another peculiarity of step C is that there is a second peak, after a big peak there is a trend in the TGA (Figure 3b) where the mass burned remains almost constant from 477°C to 622°C, with a weight loss of only 1.8%. But after 622 °C, the weight loss starts to increase making a second peak in step C. It can be noticed in a clearer way from DTG curve (Figure 3a) from 622°C up to 687°C. The peaks shown in the DTG curve of HTC pellets were defined as three zones of kinetics interest for further analysis, as pointed out in Figure 3a. In general, the smaller difference in the burning rate of the two peaks showed by the HTC pellets, compared to the bigger difference between the two peaks of step B and C of softwood pellets, strongly suggest a less chaotic burning rate and better combustion stability for the HTC pellet.

Table 2. Characteristic combustion parameters for softwood pellets and HTC pellets.

Biomass sample	Ignition Temperature (°C)	Burnout Temperature (°C)	Temperature at maximum burning rate (%/min)	Index S ($\text{min}^{-2} \cdot \text{K}^{-3}$)
Softwood pellets	257	474 (500) ^a	293	$1.45 \cdot 10^{-10}$ $(1.23 \cdot 10^{-10})^b$
HTC pellets	259	392 (687) ^a	301	$1.450 \cdot 10^{-9}$ $(2.57 \cdot 10^{-10})^b$

^a The value in brackets represents the estimated burnout temperature using conversion methods. ^b The value in brackets corresponds to the recomputed comprehensive combustion index, based on the new burnout temperature.

Table 2 shows the comprehensive combustion index S, where it clearly can be seen that the index is bigger by about one order of magnitude for HTC pellets than for softwood pellets. Some authors claim that a higher

S index indicates a higher fuel reactivity and a better fuel combustion performance. The ignition temperature of both fuels is quite similar, which means that HTC pellets are as easy to ignite as softwood pellets.

Nevertheless, the burnout temperature obtained from the tangent method is smaller for HTC than for softwood pellets but considering Figures 2 to 3, it can be noticed that the tangent method showed a poor physical meaning regarding burnout temperature. Then, using the conversion method, as it is suggested by Lu and Chen [14], HTC pellets and softwood pellets burnout temperature can be estimated again, which leads to 500°C and 687°C for softwood pellets and HTC pellets, respectively. The new burnout temperature allows recomputing a comprehensive combustion index, which in this case is for both cases in the same order but slightly better for HTC pellets.

Char oxidation is a multi-phase phenomenon and between 477°C and 722°C the inorganic compounds from the ashes form the bigger part of the remaining fuel mass. It can be that some small amount of char is trapped in the ashes, and as a consequence, a higher temperature and longer time could be required for the diffusion of oxygen to reach the char and be completely depleted. This can be the reason for higher burnout temperatures; in some way, a higher temperature will enhance the porosity of the remaining particles and as result, oxygen diffusion to the char can be enhanced.

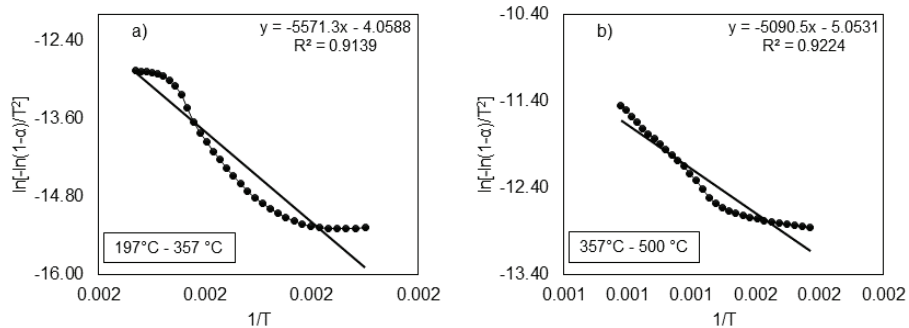

Figure 4. Fitting curve for thermal reaction stages of softwood pellets.

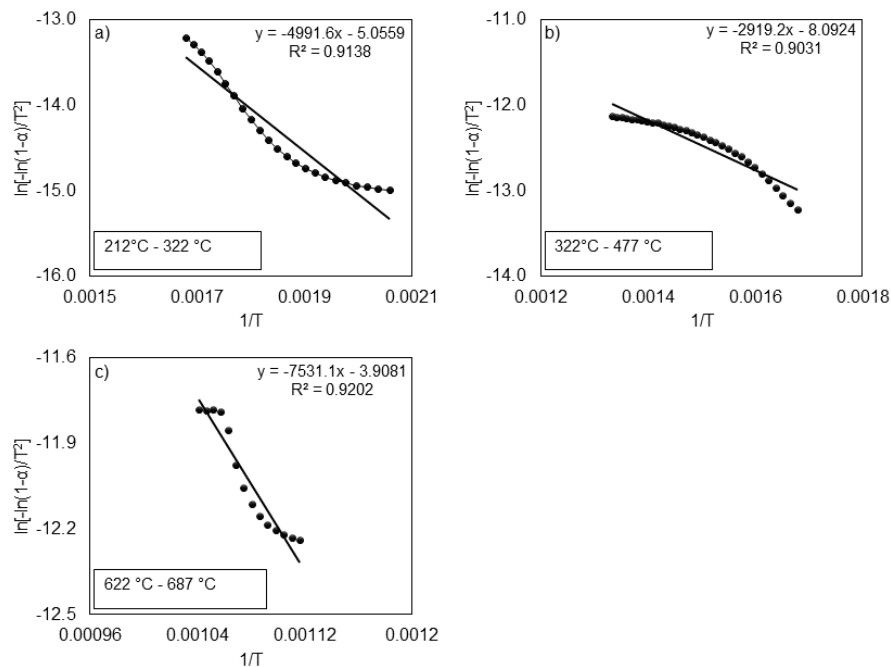

Figure 5. Fitting curve for reaction stages of HTC pellets.

Figure 4 to 5 show the fitting curves of softwood pellets and HTC pellets for different combustion reaction stages, by means of multiple first-order reactions. The TGA DTG curves for softwood pellets were divided into two main reaction stages or reaction zones, in the temperature range of 197°C to 357°C (zone I in Figure (2a)) and from 357°C to 500°C (zone II in Figure (2a)). In both reaction zones, the correlation coefficients are higher than 0.91, which suggests that the assumption of a first-order reaction might be sufficient for first-order

modelling of the pyrolysis and char oxidation processes. The first reaction zone considers the volatilization and combustion of volatiles and the second is the volatilization and combustion of char. The time of both reaction zones is quite the same, but zone II occurs at a lower burning rate than zone I, about 2.2 times lower than zone I. Table 3 shows the kinetic parameters for tall reaction zones, outlined in Figure 4 to 5. The required activation energy is bigger for zone I than for zone II, suggesting a slower reaction rate for such zones.

Table 3. Kinetic parameters in different temperature ranges.

Biomass sample	Temperature range (°C)	Activation energy (kJ/mol)	Pre-exponential factor (min ⁻¹)
Softwood pellets	197-357	46.32	1.61·10 ⁶
	357-500	42.32	3.98·10 ⁶
HTC pellets	212-322	41.50	3.92·10 ⁶
	322-477	24.27	4.77·10 ⁷
	622-687	62.61	1.88·10 ⁶

The TGA DTG curves for HTC pellets were divided into three main reaction zones, showing correlation coefficients above 0.90. The first reaction zone represents the volatilization and combustion of volatile and the second is the volatilization and combustion of the major part of char. In this case, as a highly carbonized fuel obtained by means of the HTC process, the fixed carbon is in a higher quantity than conventional lignocellulosic biomass and therefore burning rate peaks are quite similar. However, the activation energy of the reaction in zone II is 1.7 times smaller than the activation energy in reaction zone I. The combustion zone III can be assumed as an extension of the char volatilization of zone II, which requires the highest activation energy of all zones considered in HTC pellets. The analysis of zone II and III together or even the analysis of zone III alone, suggests that there is a small amount of char that is the reaction rate limiting, which kinetically speaking is the critical route of HTC pellets combustion.

3.2. Characterization of the final use of HTC pellets

Figure 6 shows the difference in boiler efficiencies between the tests performed with softwood pellets and HTC pellets, which is around 6% higher for HTC pellets.

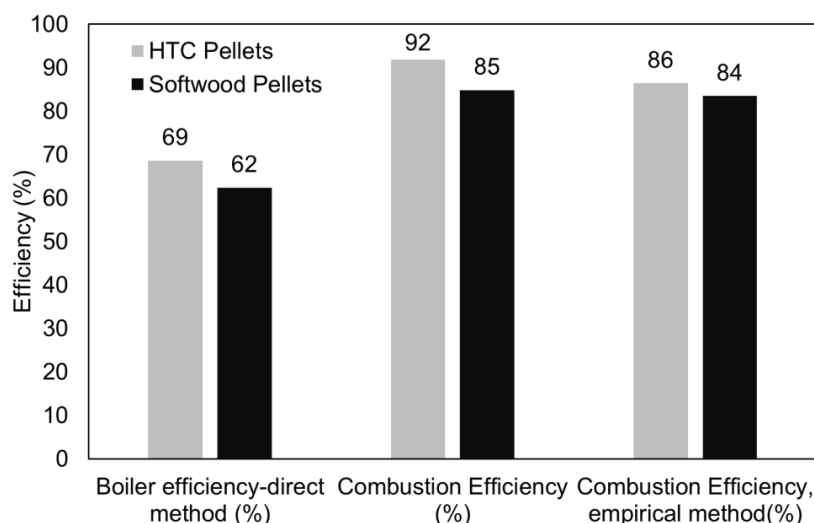

Figure 6. Boiler efficiency (direct method) and combustion efficiency calculated from indirect method and using the empirical method.

The indirect method for the calculation of the boiler efficiency showed that flue gas losses accounted for about 18% for HTC pellets and 22% for softwood pellets. The losses regarding the unburnt fuel (\dot{Q}_{UBF} term in Eq. (8)) of HTC pellets and softwood pellets were about 8% and 15%, respectively. Visual observation at the end of the tests confirmed the values obtained for losses by unburned fuel. Figure 7 shows the bottom ash collected at the end of each test. The highly unburnt charcoal in the bottom ash of softwood pellets could suggest the need for more extended boiler operation (more than 3 hours) in steady-state operation for bottom ash sampling. A complete cycle of ash out boiler bed could be necessary. Nevertheless, for the HTC pellets test without complete bottom ash out of the boiler bed, the picture of Figure 7a shows a higher charcoal burnout.

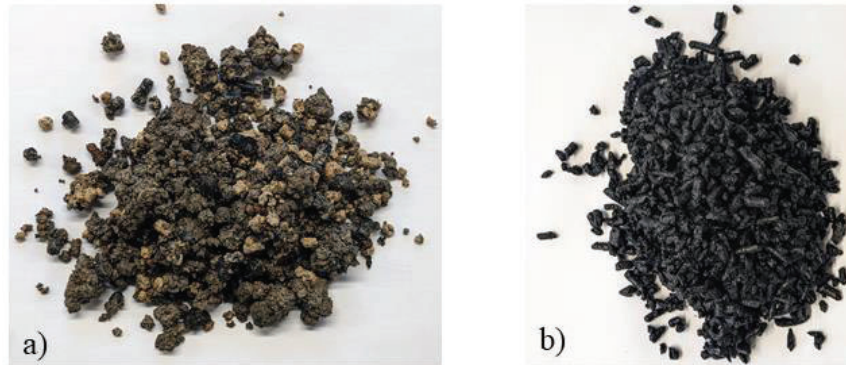

Figure 7. State of bottom ash at the end of the tests, a): HTC pellets and b): softwood pellets.

The temperature difference between exhaust gases and the environment for both fuel tests is nearly the same, with only two degrees Celsius difference between each test. Still, the difference in a loss regarding hot gases is mostly by the mass flow rate. Both fuels are burned with similar air-fuel ratios (AFR): $29.3 \text{ kg}_{\text{air}}/\text{kg}_{\text{fuel}}$ for softwood pellets and $29.5 \text{ kg}_{\text{air}}/\text{kg}_{\text{fuel}}$ for HTC pellets. Despite AFR for HTC pellets being slightly higher than for softwood pellets, the low energy density of softwood pellets makes it necessary to supply more fuel mass into the combustion chamber than for the other fuel. As a result, more air is needed, and more exhaust gases are obtained, leading to more heat losses to the atmosphere. Figure 3 shows that the combustion efficiency of HTC pellets is higher than the combustion efficiency of softwood pellets. Despite the quantitative differences shown by the methods, consistent results are obtained, as both methods tend to show that HTC pellets are more efficiently burned.

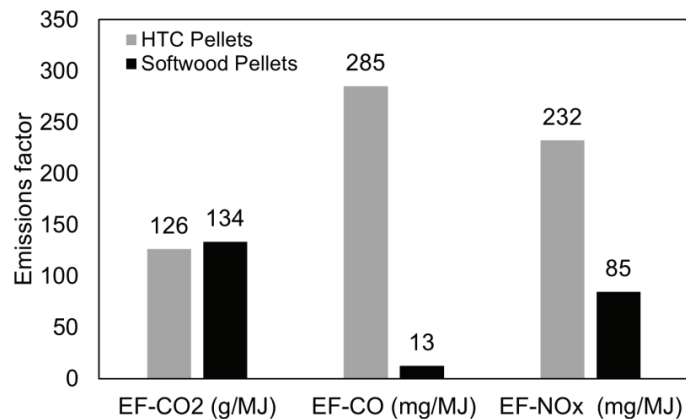

Figure 8. Emission factor for softwood and HTC pellets.

Figure 8 shows the emission factor (EF) for the measured gaseous emissions, where it can be seen that the softwood pellets emit more carbon dioxide per unit of fuel energy (7 g/MJ). This slightly higher EF for carbon dioxide could mean that softwood pellets tend to convert more carbon during the pyrolysis and gasification phases, see zone II as illustrated in Figure 4a. Indeed, the peak of the char gasification for softwood pellets occurs at a higher temperature than for HTC pellets (416°C for Softwood pellets and 336°C for HTC pellets). The volatiles released during this stage therefore find better kinetics conditions for the complete oxidation of gaseous combustible material. As expected, carbon monoxide EF is bigger for HTC pellets than for softwood pellets, which is related to the slow reaction rate of the kinetics in reaction zone III, shown in Figure 3a. On the other hand, the HTC pellets have a higher fixed-carbon content with 8.6% more fixed carbon than the softwood pellets. In general, the lower combustion efficiency showed by the softwood pellets is related to the amount of unburned char found in the bottom ash. The lower density and lower LHV of softwood pellets than HTC pellets lead to a higher mass flow rate of pellets in the fixed bed of the boiler, making it more difficult for the conditions, in terms of combustion aerodynamics and heat transfer, to reach complete char gasification and consequently oxidation.

The NO_x emissions in the boiler come from two main sources, i.e., thermal NO_x and fuel NO_x. The thermal NO_x formation route is the NO_x source attributed to the high temperature in the furnaces. The second one is associated with nitrogen content in the fuel. The first sources could be minimized by managing the boiler's air

supply and reducing the furnace's average temperature. However, regardless of how the fuel is burned, about a third of the nitrogen in solid biofuel is converted to nitrogen monoxide [35]. EF-NO_x of HTC pellets shows a considerably higher value than softwood pellets, which was expected considering that elemental analysis (see Table 1), nitrogen in the fuel is more than four times higher for HTC pellets than softwood pellets. But, considering the higher energy density of HTC pellets, thermal NO_x formation could play an essential role in the NO_x emission behaviour shown during the test.

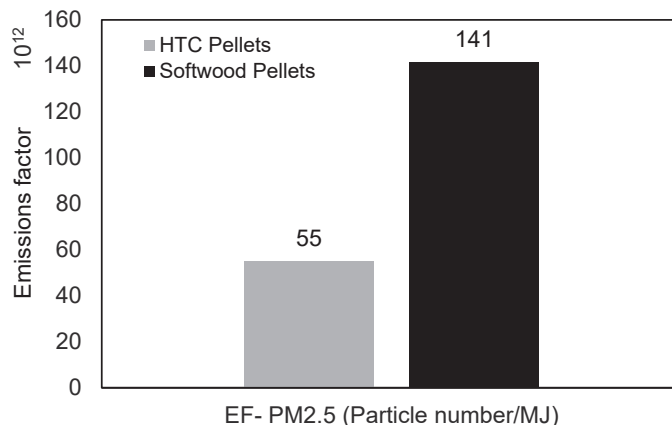

Figure 9. Emissions factor of softwood and HTC pellets for PM2.5.

The particulate matter measurements show that more than 99% of the particle's emissions were concentrated up to 2 μm. Then, the emission factor for particulate emission was computed only for PM2.5 (see Figure 9). The EF-PM2.5 for HTC pellets was more than two times higher than for softwood pellets. Figure 9 shows that for particles diameter between 0.0091 to 0.0248 μm, PM emission for softwood pellets was higher than for HTC pellets. Still, for particle diameter from 0.0406 to 3.0169 μm HTC pellets, PM2.5 emission was far higher than for softwood pellets. It can be realized that more than 99% of particles' emissions up to 2 μm are concentrated between particle diameters from 0.0091 μm to 0.43 μm.

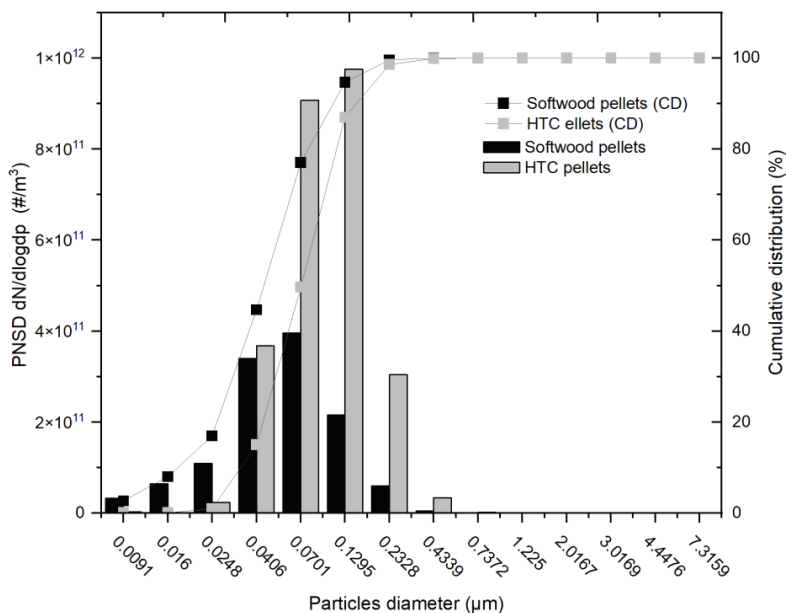

Figure 10. Particle number distribution and distribution of cumulative particle diameter.

Figure 11 clearly shows how the PM emission of softwood pellets is higher in the zone of smaller particle diameter and higher particle diameter than HTC pellets particles emission. Nevertheless, the total particle number emission was higher for HTC pellets than for softwood pellets.

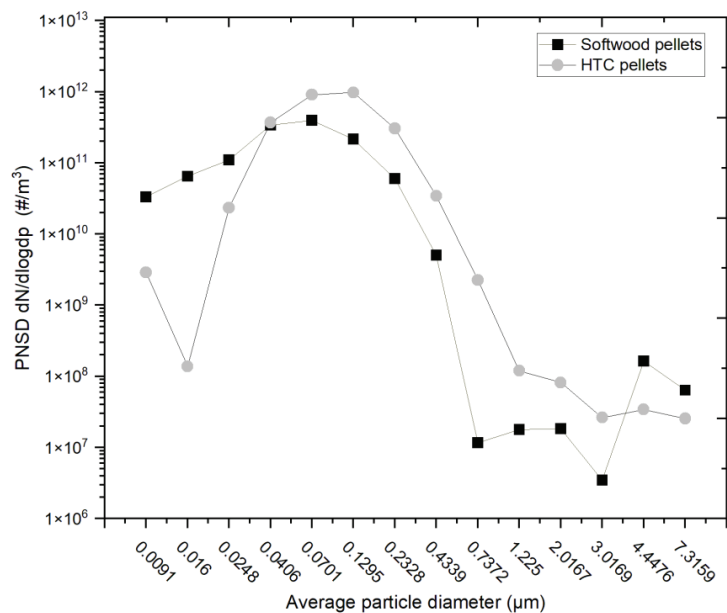

Figure 11. Particle-number size distribution (PNSD) versus average particle's diameter in logarithm coordinate.

4. Conclusions

In this paper, a comparative study has been carried out on the combustion kinetics, efficiencies and emissions of HTC pellets and softwood pellets.

The kinetics study of softwood pellets showed two characteristic peaks in combustion zone I and II, as expected and the activation energies were found to be quite similar in both reaction zones. However, HTC pellets showed a presumed small amount of char to be gasified in reaction zone III, which takes quite a higher activation energy to start its conversion and therefore gives rise to a very slow reaction rate.

The combustion tests of softwood pellets and HTC pellets have shown that HTC pellets outperform softwood pellets in terms of boiler efficiency and combustion efficiency. However, HTC pellets showed a higher emission factor for carbon monoxide and NO_x compared to softwood pellets. For both emission factors, it seems that some optimization in terms of the air-fuel ratio can be performed to reduce the average temperature in the combustion chamber and to increase the mixing of the air and the fuel. Both effects are highly desired to minimize thermal NO_x and CO emissions, respectively. Nevertheless, the particulate emission showed a high number of particles in the combustion of HTC pellets. Therefore, special attention is required for the correct setting of the air-fuel ratio during the combustion of HTC pellet fuel.

Acknowledgements

This study was conducted with the support of the VUB University scholarship, which is funded by the VLIR-UOS program of the Flemish government.

References

1. Baul, T.K., et al., *Net climate impacts and economic profitability of forest biomass production and utilization in fossil fuel and fossil-based material substitution under alternative forest management*. Biomass and Bioenergy, 2017. **98**: p. 291-305.
2. Queneau, Y. and B. Han, *Biomass: Renewable carbon resource for chemical and energy industry*. The Innovation, 2022. **3**(1): p. 100184.
3. Lindberg, D., et al., *Towards a comprehensive thermodynamic database for ash-forming elements in biomass and waste combustion — Current situation and future developments*. Fuel Processing Technology, 2013. **105**: p. 129-141.
4. Brigagão, G.V., et al., *A techno-economic analysis of thermochemical pathways for corncob-to-energy: Fast pyrolysis to bio-oil, gasification to methanol and combustion to electricity*. Fuel Processing Technology, 2019. **193**: p. 102-113.
5. Li, Y., et al., *Synergistic effect of combined hydrothermal carbonization of Fenton's reagent and biomass enhances the adsorption and combustion characteristics of sludge towards eco-friendly and efficient sludge treatment*. Science of The Total Environment, 2022. **825**: p. 153854.

6. Basu, P., *Chapter 4 - Torrefaction*, in *Biomass Gasification, Pyrolysis and Torrefaction (Second Edition)*, P. Basu, Editor. 2013, Academic Press: Boston. p. 87-145.
7. Kim, D., K. Lee, and K.Y. Park, *Hydrothermal carbonization of anaerobically digested sludge for solid fuel production and energy recovery*. *Fuel*, 2014. **130**: p. 120-125.
8. Koppejan, J. and S. Van Loo, *The handbook of biomass combustion and co-firing*. 2012: Routledge.
9. Sitek, T., et al., *Thermogravimetric analysis of solid biomass fuels and corresponding emission of fine particles*. *Energy*, 2021. **237**: p. 121609.
10. Cornette, J.F.P., et al., *Particulate matter emission reduction in small- and medium-scale biomass boilers equipped with flue gas condensers: Field measurements*. *Biomass and Bioenergy*, 2021. **148**: p. 106056.
11. Cornette, J., *Experimental and numerical assessment of particle size distributions from solid biomass combustion*, in *Mechanical Department*. 2022, Vrije Universiteit Brussel: Brussels.
12. Liu, J., et al., *Study of Combustion Characteristics and Kinetics of Agriculture Briquette Using Thermogravimetric Analysis*. *ACS Omega*, 2021. **6**(24): p. 15827-15833.
13. Escalante, J., et al., *Pyrolysis of lignocellulosic, algal, plastic, and other biomass wastes for biofuel production and circular bioeconomy: A review of thermogravimetric analysis (TGA) approach*. *Renewable and Sustainable Energy Reviews*, 2022. **169**: p. 112914.
14. Lu, J.-J. and W.-H. Chen, *Investigation on the ignition and burnout temperatures of bamboo and sugarcane bagasse by thermogravimetric analysis*. *Applied Energy*, 2015. **160**: p. 49-57.
15. Rago, Y.P., et al., *Co-combustion of torrefied biomass-plastic waste blends with coal through TGA: Influence of synergistic behaviour*. *Energy*, 2022. **239**: p. 121859.
16. Moon, C., et al., *Effect of blending ratio on combustion performance in blends of biomass and coals of different ranks*. *Experimental Thermal and Fluid Science*, 2013. **47**: p. 232-240.
17. Hoang, A.T., et al., *Progress on the lignocellulosic biomass pyrolysis for biofuel production toward environmental sustainability*. *Fuel Processing Technology*, 2021. **223**: p. 106997.
18. Bridgwater, A.V., D. Meier, and D. Radlein, *An overview of fast pyrolysis of biomass*. *Organic Geochemistry*, 1999. **30**(12): p. 1479-1493.
19. Kissinger, H.E., *Reaction Kinetics in Differential Thermal Analysis*. *Analytical Chemistry*, 1957. **29**(11): p. 1702-1706.
20. Akahira, T. and T. Sunose, *Method of determining activation deterioration constant of electrical insulating materials*. *Res Rep Chiba Inst Technol (Sci Technol)*, 1971. **16**(1971): p. 22-31.
21. Flynn, J.H. and L.A. Wall, *A quick, direct method for the determination of activation energy from thermogravimetric data*. *Journal of Polymer Science Part B: Polymer Letters*, 1966. **4**(5): p. 323-328.
22. Ozawa, T., *A new method of analyzing thermogravimetric data*. *Bulletin of the chemical society of Japan*, 1965. **38**(11): p. 1881-1886.
23. Coats, A.W. and J.P. Redfern, *Kinetic Parameters from Thermogravimetric Data*. *Nature*, 1964. **201**(4914): p. 68-69.
24. Nussbaumer, T. and J. Good. *Determination of the combustion efficiency in biomass furnaces*. in *Proceedings 10th European conference and technology Exhibition biomass for energy, industry and climate protection. Würzburg*. 1998.
25. Good, J. and T. Nussbaumer, *Wirkungsgradbestimmung bei Holzfeuerungen*. 1993: Bezugsquelle.
26. Good, J., et al., *Determination of the efficiencies of automatic biomass combustion plants*. *Verenum*. International Energy Agency, IEA. Bioenergy Task, 2006. **32**.
27. Lyubov, V.K., et al., *Determining heat loss into the environment based on comprehensive investigation of boiler performance characteristics*. *Thermal Engineering*, 2015. **62**(8): p. 572-576.
28. TNO, E., *Phyllis2, database for (treated) biomass, algae, feedstocks for biogas production and biochar*. 2020, Von Phyllis2, database for (treated) biomass, algae, feedstocks for biogas
29. ENGIE-Laborelec, *Solid biofuel analysis*. 2022, Biomass Lab of Laborelec: Brussels. p. 3.
30. Mason, D.M. and K.N. Gandhi, *Formulas for calculating the calorific value of coal and coal chars: Development, tests, and uses*. *Fuel Processing Technology*, 1983. **7**(1): p. 11-22.
31. Gil, M.V., et al., *Mechanical durability and combustion characteristics of pellets from biomass blends*. *Bioresource Technology*, 2010. **101**(22): p. 8859-8867.
32. Jiang, L., et al., *A comparative study of biomass pellet and biomass-sludge mixed pellet: Energy input and pellet properties*. *Energy Conversion and Management*, 2016. **126**: p. 509-515.
33. Jia, G., *Combustion characteristics and kinetic analysis of biomass pellet fuel using thermogravimetric analysis*. *Processes*, 2021. **9**(5): p. 868.
34. Chen, D., et al., *Investigation of biomass torrefaction based on three major components: Hemicellulose, cellulose, and lignin*. *Energy Conversion and Management*, 2018. **169**: p. 228-237.
35. Vakkilainen, E.K., *2 - Solid Biofuels and Combustion*, in *Steam Generation from Biomass*, E.K. Vakkilainen, Editor. 2017, Butterworth-Heinemann. p. 18-56.